

F80 & F130 FLEX-SELECT® Series

Adaptable Broadcast Spreader

Assembly and Operating Instructions

EarthWay®
EV-N-SPRED
FLEX-SELECT

PLEASE CONTACT US: IF YOU ARE MISSING ANY PARTS, HAVE ANY DIFFICULTY IN ASSEMBLY, OR HAVE ANY QUESTIONS REGARDING THE SAFE OPERATION OF THIS SPREADER. THIS MODEL INCLUDES LIFETIME TECHNICAL SUPPORT. **SUPPORT HOT LINE: 574-848-7491 or 800-294-0671, email: techsupport@earthway.com**

HELPFUL HINTS:

- ☑ If your spreader does not spread evenly, be sure the FRONT on the gear box points to the front of the spreader. The impeller must turn clockwise. Reversing the gearbox will cause the impeller to turn counter clockwise. Clean the impeller after each use as some fertilizer may become stuck on the impeller blades and will cause uneven spreading.
- ☑ Your spreader is designed to be pushed at three miles per hour, which is a brisk walking speed. Slower or faster speeds will change the spread patterns. Wet fertilizer will also change the spread pattern and flow rate.
- ☑ Clean and dry your spreader thoroughly after each use, wash between the shut-off plate and bottom of the hopper regularly. To prevent rust, coat all metal parts (inside and out) including the frame tubes with a light oil, silicon spray, or Fluid Film®.
- ☑ Gears are permanently lubricated at the factory. Do not open the gearbox or dirt may enter.
- ☑ When using **Rock Salt** to prevent damage to the gearbox remove salt from the hopper daily. **Rock Salt** will reconstitute back into a solid block if left in the hopper overnight and will damage your gearbox if pushed with the salt in place.

WARNING

Do not use air tools to assemble.
To prevent seizing coat all bolts with a wax or grease prior to installation.



Remove all parts, hardware, and assemblies from carton and lay them out on the floor to help in assembly.

Below are tools needed for assembly - 7/16" wrench, ratchet and 7/16" socket, and pliers.

The following photos are for assembly purposes, and please follow them from left to right, top to bottom.



Download a color version of this manual online at www.earthway.com or Scan this QR Code.



9-2014 Pt# F52157 PAGE 1

ASSEMBLY



ASSEMBLY - continued →



ASSEMBLY - continued →

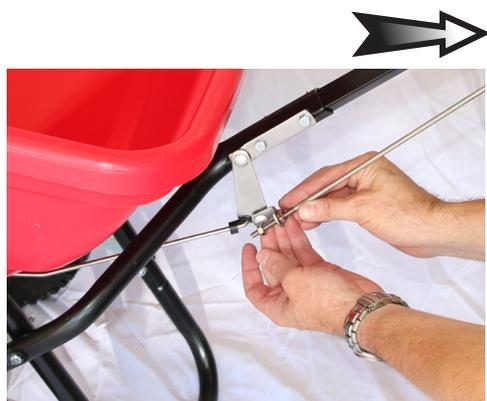
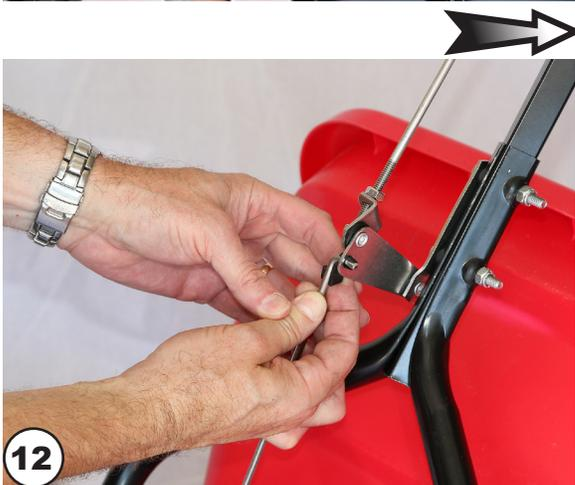
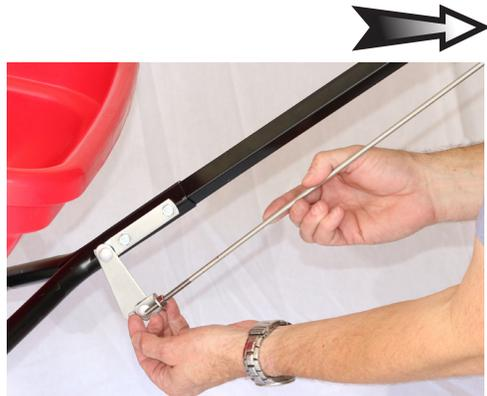
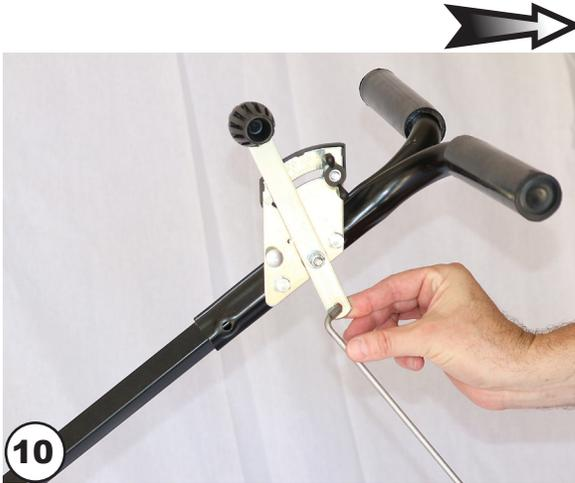
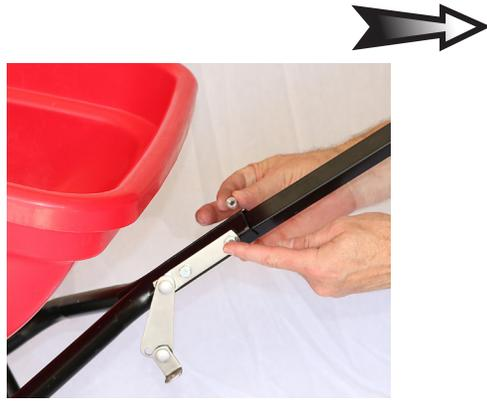

ASSEMBLY - continued →



CONFIRM THE CALIBRATION:
Lever at #30 and the drop holes fully open

COMPLETE ASSEMBLY:
Install agitator, bend the agitator up slightly
to prevent contact with the standard output tray,
and install debris screen
(press over 1/4 turn fasteners to secure)

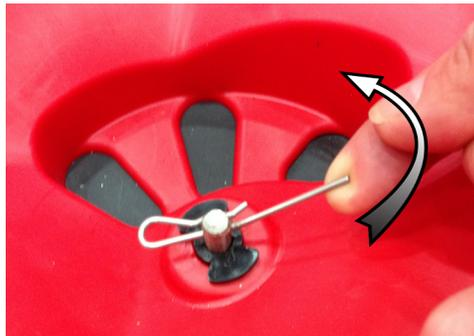
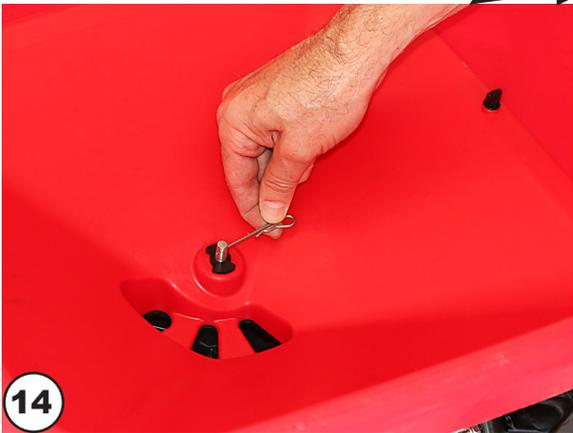

TRAY INSTALLATION



HIGH-OUTPUT AND LOW-OUTPUT:
require the use of the Part #F12117



HIGH-OUTPUT AND LOW-OUTPUT:
require the use of the Part #F12117



SPREAD PATH

FULL Rate (one pass)

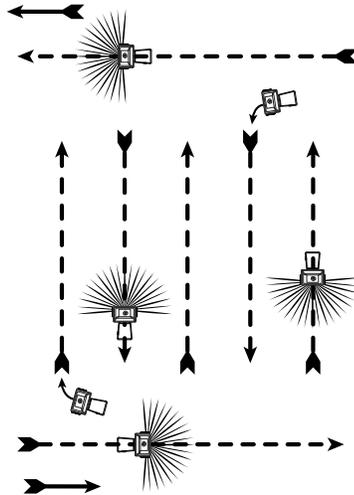

HALF Rate (two passes)

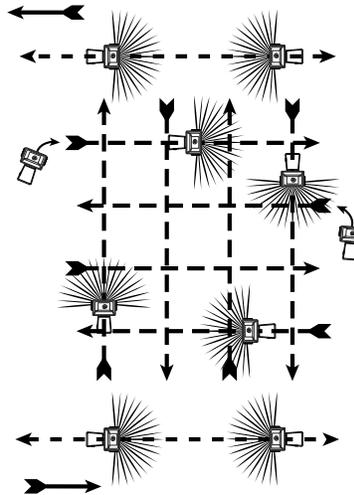

© 2013 Earthway Products, Inc. All rights reserved

OPERATING INSTRUCTIONS

Before filling hopper, become familiar with the operation of this spreader.

- Obtain proper setting for material to be used from the enclosed SETTING MATRIX included with this spreader, or from our web site under the MANUALS SECTION.
- Move stop bolt on rate gauge assembly to the proper setting.
- While pushing spreader forward, pull control lever back to stop bolt.
- To stop, push lever forward to close flow holes before you stop moving.
- When finished, empty any remaining material from hopper.
- Thoroughly wash spreader and allow to dry before storing. Apply coating of light oil to help prevent corrosion.
- If you use Rock Salt, **remove agitator** when using Rock Salt to prevent damage to the gearbox.

Earthway Products, Inc.
1009 Maple Street, PO Box 547
Bristol, IN 46507

For Your Records

Date Purchased

Place of Purchase

HOW TO ORDER SPARE PARTS

All spare parts listed may be ordered direct from
EarthWay Products, Inc.

Be sure to give the following information when ordering.

Model Number

Part Number

Part Description

Call (574) 848-7491, 800-294-0671, or email: parts@earthway.com for current prices.

Using the EV-N-SPRED® Dual Port PRO Adjustable Shut-Off System - *Included with Optional F13130DKit Tray*

EarthWay®
EV-N-SPRED®

The EV-N-SPRED® Dual Port PRO Adjustable Shut-Off System is included on all Professional models and allows the operator to balance the spread pattern evenly across the full 180° spread width, regardless of the weight or size of granular material. By closing either the right and or left side throwing ports you can balance the spread pattern to exacting precision without compromising spread width or application rate.

Each EV-N-SPRED® Dual Port PRO Adjustable Shut-Off System drop hole has a corresponding 1/3rd coverage area on the spread width of the spreader leaving a feathered-edge for overlapping the spread path. The illustration to the right shows each port and the corresponding 1/3rd coverage area of the spread path. These ports can be adjusted to effectively balance the spread pattern, giving equal amounts of material across the full 180° spread pattern.

EV-N-SPRED® Dual Port PRO System Setup

Test all material prior to beginning your spreading job. You will need a 50' measuring tape, a small scale to weigh the material, bucket or container to hold the material for re-weighing, chalk or a line marking device, and (7) low baking tins. *Using the EarthWay® Bag Calibrator #77016 can greatly reduce the time needed for determining the Setting Rates on any material but is not mandatory to establish a setting rate.*

1. Evaluate the material being spread by comparing it to the following standard as a reference.

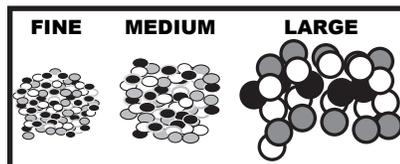

Large/Heavy is the size of a BB (1/8 in / 3mm), spread width is 28 - 36 feet (8.5 - 11 meters)

Medium/Mixed (1/2 the size of a BB), spread width is 20 - 24 feet (6.1 - 7.3 meters)

Small/Fine (the size of sand), spread width is 16 - 18 feet (4.8 - 5.5 meters)

2. Add a small amount of the material into the spreader, enough to cover the bottom (2-3 in / 5 - 7 cm) and begin to test for spread width. Set the stop on the gauge to #15 and push the spreader several feet /meters at normal walking speed on a flat hard surface (where the material will be visible), and OPEN the lever to the STOP while continuing to walk for 3-4 paces, and CLOSE the shut-off and STOP (don't move the spreader from that position). Measure the spread width and evaluate the spread pattern for even distribution on either side of the spread width center line. **TIP:** Typical spread width references are listed above. *The spread width that you measure is used to calculate the actual **Setting Rate** for the material.*

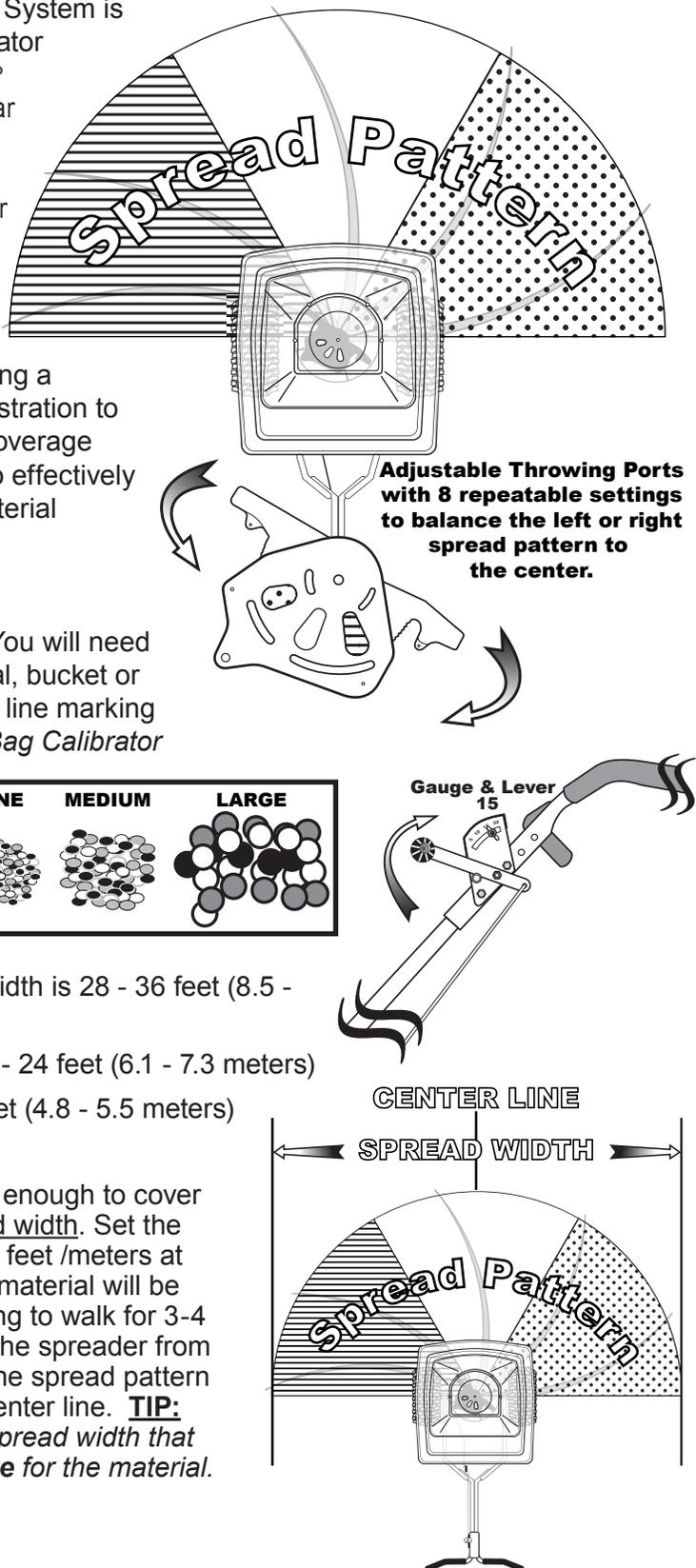

ADJUSTING THE EV-N-SPRED® DUAL PORT SHUT-OFF SYSTEM

Next, using the (7) low baking tins position, them in a straight line on 2-foot centers across the spread width as shown at the right.

Adjust the left or right variable throwing ports to EVEN THE SPREAD pattern.

TIP: For large/heavy materials, close the **LEFT SIDE (LINES)** port slightly before you start your EV-N-SPRED® test. For small/light materials, open the **LEFT SIDE (LINES)** port fully and close the **RIGHT SIDE (CIRCLES)** port slightly before you start your EV-N-SPRED® test. With **BOTH** ports closed, the spread is only from the center port, and will give you a 3-4ft spread width in the center of the spreader - *great for medians*.

Begin pushing the spreader several feet before the line of tins and at normal walking speed. Walk along the Center Line, and **OPEN** the Lever to the **STOP** 3-4 paces before the line of tins and continue walking past the tins 1 or 2 paces and **CLOSE** the Lever and **STOP**.

Visually evaluate the material in the baking tins to determine if your spread pattern is balanced - *having the same amount of material in each baking tin*.

Empty each tin back into the spreader, adjust the ports and **RETEST** until you are satisfied that the coverage is balanced.

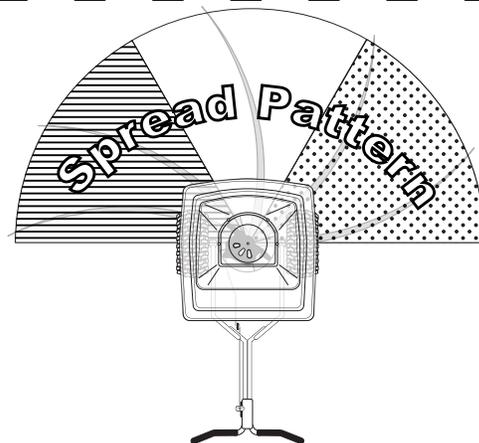
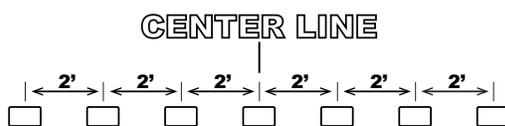
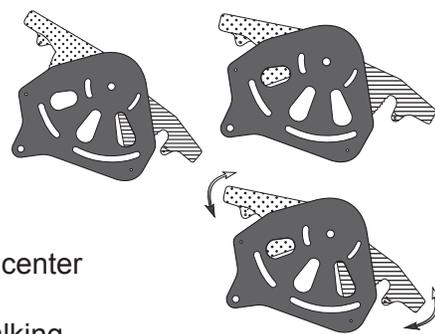

Spread width in feet	Length needed for 1,000 Sq Ft	Spread width in feet	Length needed for 1,000 Sq Ft	Spread width in feet	Length needed for 1,000 Sq Ft
7	142' 10"	17	58' 10"	27	37'
8	125'	18	55' 7"	28	35' 9"
9	111' 1"	19	52' 7"	29	34' 6"
10	100'	20	50'	30	33' 4"
11	90' 11"	21	47' 7"	31	32' 3"
12	83' 4"	22	45' 5"	32	31' 3"
13	76' 11"	23	43' 6"	33	30' 4"
14	71' 5"	24	41' 8"	34	29' 5"
15	66' 8"	25	40'	35	28' 7"
16	62' 6"	26	38' 6"	36	27' 9"

ESTABLISH THE SETTING RATE

Remove the material from the hopper, and mark the distance that you need to travel with the spreader to attain the designated coverage area - i.e. 1,000 square feet using the spread width you determined earlier. *Above is a chart to help determine the distance needed for 1,000 square foot calculation.*

Mark the **START** and **END POINTS** on the surface required for the test. Weigh a small amount (10-20lbs/4-9kg) of the material, and add that into to the spreader. Using the Setting Matrix included with the spreader, estimate a setting rate based on material manufacturers recommendations and adjust the **STOP** on the Gauge to that position.

Now to test, start walking 1-2 paces before the **START LINE** and **OPEN** the Lever to the stop and then **CLOSE** when you cross the **END POINT LINE**.

Pour the remaining material from the spreader and weigh to calculate the amount applied over the area. Adjust the **Setting Rate** to a higher number if you need to increase the application rate, or to a lower number if you applied too much in the test.

You may need to repeat this process to acquire the exact rate.

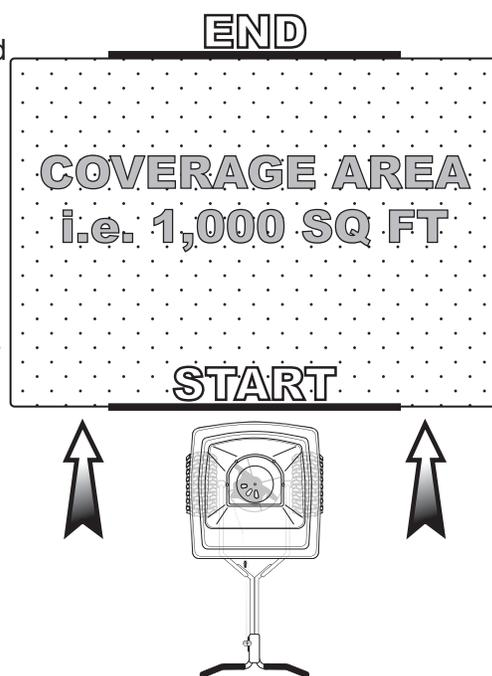

The EV-N-SPRED® Dual Port PRO Adjustable Shut-Off System ensures that EarthWay® Professional spreaders evenly spread all types of fertilizers, seed, ice melt, or other granular products, and is only available from EarthWay®.

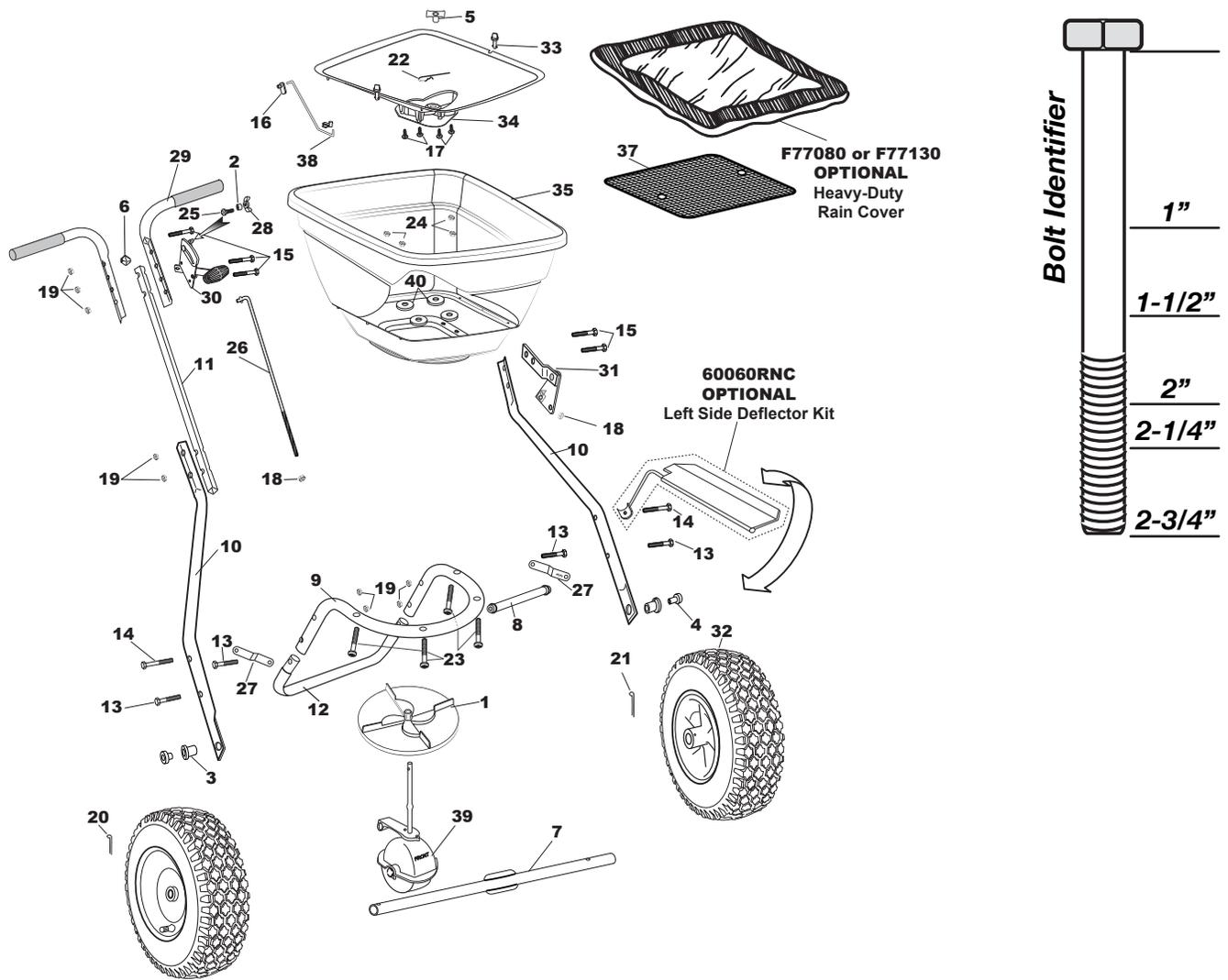

F80 & F130 COMMERCIAL BROADCAST SPREADER

Key #	Part #	Description	Key #	Part #	Description
1	12110	IMPELLER 9" ROUND DISHED	23	36214	1/4-20 X 1 1/2" PHPMS S.S.
2	12147	SPACER (PIVOT LINK)	24	36300	1/4-20 NYLON INSERT LOCKNUT S.S.
3	12148	AXLE BEARING	25	37100	1/4-20 X 1" CARRIAGE BOLT ZINC
4	12152	AXLE BUSHING	26	42256	CONTROL ROD
5	12209	HOPPER BUSHING	27	44249	FRAME BRACE
6	12344	HANDLE SPACER	28	60027	WING NUT ASSEMBLY BLACK
7	24500	AXLE	29	60175	UPPER HANDLE SQUARE W/GRIP ea
8	25228	CROSS BRACE 11.25"	30	60298	GAUGE & LEVER ASSEMBLY
9	25108	FRAME	31	60300	PIVOT & BRACKET ASSEMBLY
10	25222	LOWER HANDLE	32	70138	PNEUMATIC DRIVE WHEEL STUD
11	25223	HANDLE SHAFT	33	F12135	1/4 TURN FASTENER FLEX SELECT
12	25723	FRAME Foot	34	F12219	STANDARD OUTPUT FLEX-SELECT SHUTOFF
13	31100	1/4-20 X 1 1/2 HHMS ZINC	35	F13105	FLEX-SELECT 80# HOPPER / F13106 FLEX-SELECT 130# HOPPER
14	31106	1/4-20 X 2 1/4" HHCS ZINC	36	F13130	STANDARD OUTPUT FLEX-SELECT TRAY KIT
15	31120	1/4-20 X 2" HHCS ZINC	37	F40003	SQUARE SCREEN FLEX-SELECT
16	31127	ROD CLIP (Flex-Select)	38	F44251	PIVOT ROD STD OUTPUT FLEX-SELECT
17	31138	#8 X 3/8" PMT #8 HD COARSE BLACK	39	F60333	GEAR BOX ASSEMBLY FLEX -SELECT
18	32100	1/4-20 HEX NUT ZINC	40	43020	BACKPLATE WASHER (FOR F130)
19	32103	1/4-20 NYLON INS LOCKNUT ZINC	Optional	60060RNC	SIDE DEFLECTOR
20	33108	3/16" X 1" COTTER PIN ZINC	Optional		HEAVY DUTY RAIN COVER (F77080 for F80 / F77130 FOR F130)
21	33109	3/16" X 2" COTTER PIN ZINC	Optional	12195	GAUGE OVERLAY- LESCO SETTINGS
22	33117	AGITATOR	Standard	12196	GAUGE OVERLAY- EARTHWAY

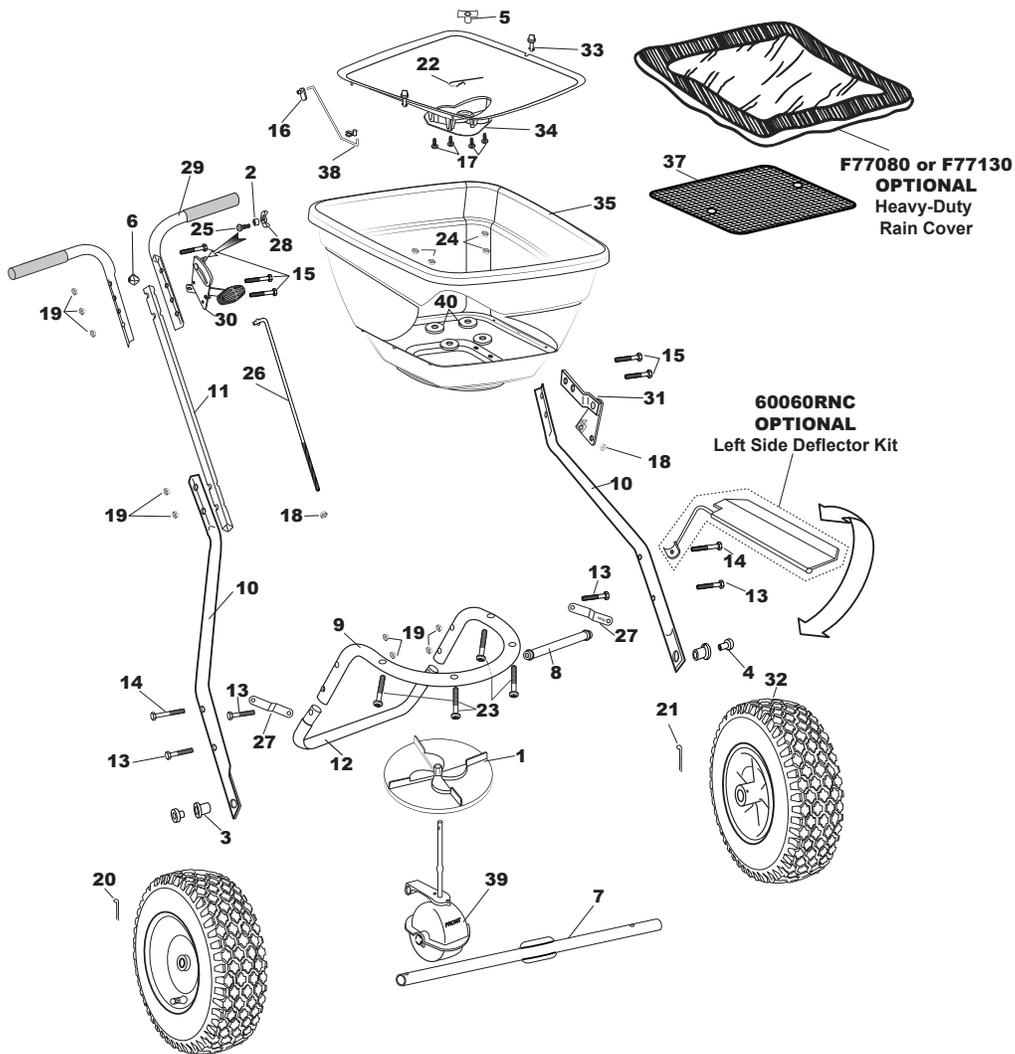

F80S & F130S COMMERCIAL BROADCAST SPREADER

Key #	Part #	Description	Key #	Part #	Description
1	12110	IMPELLER 9" ROUND DISHED	23	36214	1/4-20 X 1 1/2" PHPMS S.S.
2	12147	SPACER (PIVOT LINK)	24	36300	1/4-20 NYLON INSERT LOCKNUT S.S.
3	12148	AXLE BEARING	25	37100	1/4-20 X 1" CARRIAGE BOLT ZINC
4	12152	AXLE BUSHING	26	42256	CONTROL ROD
5	12209	HOPPER BUSHING	27	44249	FRAME BRACE
6	12344	HANDLE SPACER	28	60027	WING NUT ASSEMBLY BLACK
7	24500	AXLE	29	60175-SS	UPPER HANDLE SQUARE STAINLESS W/GRIP ea
8	25228	CROSS BRACE 11.25"	30	60298	GAUGE & LEVER ASSEMBLY
9	24111	FRAME	31	60300	PIVOT & BRACKET ASSEMBLY
10	25222-SS	LOWER HANDLE	32	70138	PNEUMATIC DRIVE WHEEL STUD
11	25223-SS	HANDLE SHAFT	33	F12135	1/4 TURN FASTENER FLEX SELECT
12	25723-SS	FRAME FOOT SS	34	F12219	STANDARD OUTPUT FLEX-SELECT SHUTOFF
13	36200	1/4-20 X 1 1/2" HHCS S.S.	35	F13105	F13105 FLEX-SELECT 80# HOPPER / F13106 FLEX-SELECT 130# HOPPER
14	36205	1/4-20 X 2 1/4" HHCS S.S.	36	F13130	STANDARD OUTPUT FLEX-SELECT TRAY KIT
15	36216	1/4-20 X 2" HHCS S.S.	37	F40003	SQUARE SCREEN FLEX-SELECT
16	31127	ROD CLIP (Flex-Select)	38	F44251	PIVOT ROD STD OUTPUT FLEX-SELECT
17	31138	#8 X 3/8" PMT #8 HD COARSE BLACK	39	F60333	GEAR BOX ASSEMBLY FLEX -SELECT
18	32100	1/4-20 HEX NUT ZINC	40	43020	BACKPLATE WASHER (FOR F130)
19	32103	1/4-20 NYLON INS LOCKNUT ZINC	Optional	60060RNC	SIDE DEFLECTOR
20	36103	3/16 X 2" COTTER PIN S.S.	Optional		HEAVY DUTY RAIN COVER (F77080 for F80 / F77130 FOR F130)
21	36104	3/16 X 1" COTTER PIN S.S.	Optional	12195	GAUGE OVERLAY- LESCO SETTINGS
22	33117	AGITATOR	Standard	12196	GAUGE OVERLAY- EARTHWAY

STANDARD-OUTPUT F13130KIT

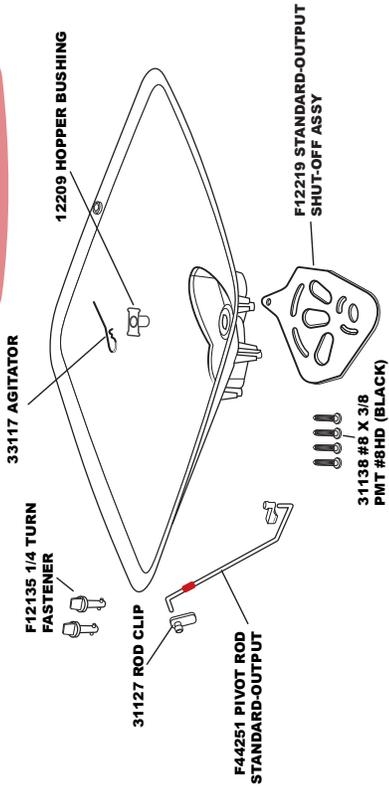
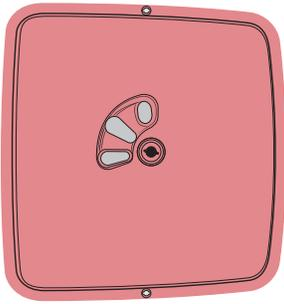

LOW-OUTPUT F13130LKIT

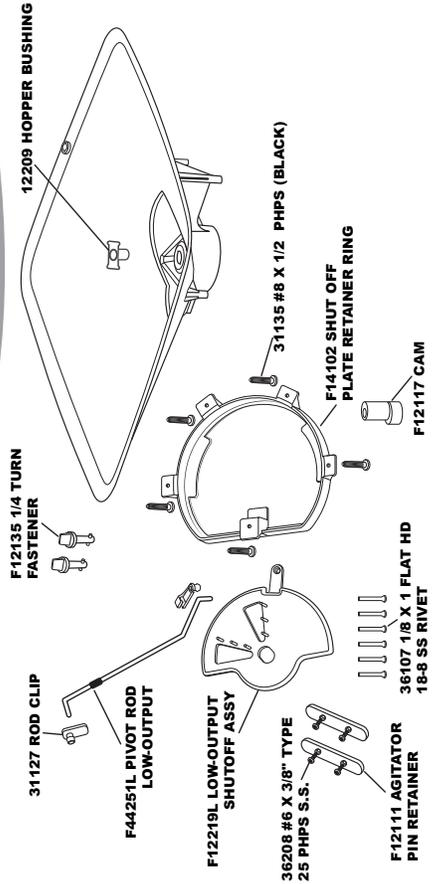
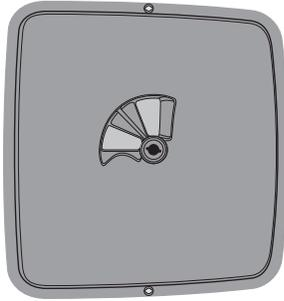

STANDARD-OUTPUT PRO F13130DKIT

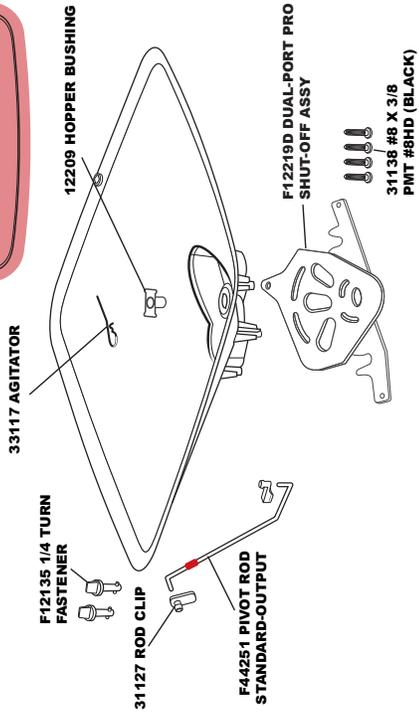
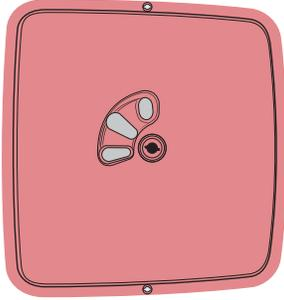

HIGH-OUTPUT F13130HKIT

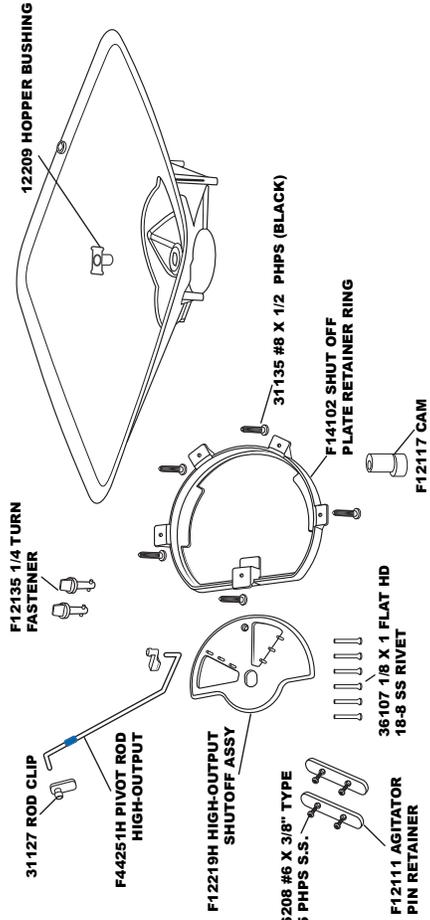
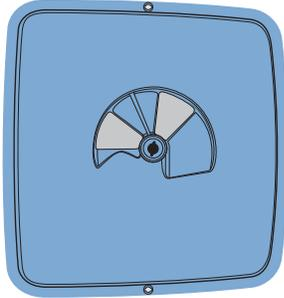

FLEX-SELECT® BROADCAST SPREADER SETTING MATRIX

GRANULAR MATERIAL

STANDARD-OUTPUT Red Tray

PARTICLE SIZES: Fine/Small →
(SAND)

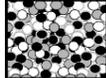

Medium →
(HALF BB)

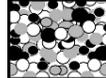

Large →
(BB) Ice Melt

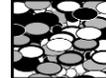

LBS. PER 1,000 SQUARE FEET	SETTING	SPREAD		SETTING	SPREAD		SETTING	SPREAD	
		WIDTH FT	METERS		WIDTH FT	METERS		WIDTH FT	METERS
1 LB.	7	18'	5.5m	9	24'	7.3m	14	36'	11m
2 LBS.	10	18'	5.5m	13	24'	7.3m	18	36'	11m
3 LBS.	13	18'	5.5m	16	24'	7.3m	23	36'	11m
4 LBS.	14	18'	5.5m	20	24'	7.3m	27	36'	11m
5 LBS.	16	18'	5.5m	22	24'	7.3m	30	36'	11m
6 LBS.	18	18'	5.5m	25	24'	7.3m	23 = 2 pass	36'	11m
7 LBS.	20	18'	5.5m	27	24'	7.3m	25 = 2 pass	36'	11m
8 LBS.	22	18'	5.5m	28	24'	7.3m	27 = 2 pass	36'	11m
9 LBS.	24	18'	5.5m	30	24'	7.3m	28 = 2 pass	36'	11m
10 LBS.	26	18'	5.5m	22 = 2 pass	24'	7.3m	30 = 2 pass	36'	11m

GRASS SEED



LBS. PER 1,000 SQUARE FEET	FINE		COARSE			
	SETTING	SPREAD WIDTH FT	SETTING	SPREAD WIDTH FT		
2 LBS.	14	8'	2.4m	22	14'	4.3m
3 LBS.	16	8'	2.4m	25	14'	4.3m
4 LBS.>	18	8'	2.4m	28	14'	4.3m
5 LBS.>	20	8'	2.4m	30	14'	4.3m

Calibration: Start by ensuring that your spreader calibration is correct. Make sure the drop holes in the **Standard-Output Tray** are fully open when the Rate Control handle is on #30. If not, please adjust control rod at the pivot to allow for a full open hopper holes with the handle at position at #30.

GRANULAR MATERIAL

LOW-OUTPUT Black Tray

PARTICLE SIZES: Fine/Small →
(SAND)

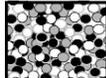

Medium →
(HALF BB)

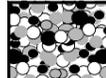

LBS. PER 1,000 SQUARE FEET	SETTING	SPREAD		SETTING	SPREAD	
		WIDTH FT	METERS		WIDTH FT	METERS
1 LB.	8	16'	4.9m	10	20'	6.1m
2 LBS.	10	16'	4.9m	13	20'	6.1m
3 LBS.	12	16'	4.9m	18	20'	6.1m
4 LBS.	13	16'	4.9m	20	20'	6.1m
5 LBS.	16	16'	4.9m	22	20'	6.1m
6 LBS.	18	16'	4.9m	25	20'	6.1m
7 LBS.	20	16'	4.9m	27	20'	6.1m
8 LBS.	21	16'	4.9m	29	20'	6.1m
9 LBS.	23	16'	4.9m	30	20'	6.1m
10 LBS.	24	16'	4.9m	22 = 2 pass	20'	6.1m

Calibration: Start by ensuring that your spreader calibration is correct. Make sure the drop holes in the **LOW-OUTPUT TRAY** are fully closed when the Rate Control Handle is resting on the stop #0. If not, please adjust control rod at the pivot to ensure the shut-off is fully closed with the handle at position at #0. Move the spreader slightly to confirm the calibration because of the cam.

GRANULAR MATERIAL

HIGH-OUTPUT Lt. Blue 2-hole Tray

PARTICLE SIZES: Large →
(BB)

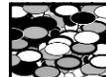

EXTRA LARGE →
ROCK SALT



LBS. PER 1,000 SQUARE FEET	SETTING	SPREAD		SETTING	SPREAD	
		WIDTH FT	METERS		WIDTH FT	METERS
1 LB.	7	28'	8.5m	8	26'	7.9m
2 LBS.	10	28'	8.5m	11	26'	7.9m
3 LBS.	12	28'	8.5m	13	26'	7.9m
4 LBS.	14	28'	8.5m	14	26'	7.9m
5 LBS.	15	28'	8.5m	15	26'	7.9m
6 LBS.	17	28'	8.5m	16	26'	7.9m
7 LBS.	20	28'	8.5m	17	26'	7.9m
8 LBS.	21	28'	8.5m	18	26'	7.9m
9 LBS.	23	28'	8.5m	19	26'	7.9m
10 LBS.	24	28'	8.5m	21	26'	7.9m

Calibration: Start by ensuring that your spreader calibration is correct. Make sure the drop holes in the **HIGH-OUTPUT TRAY** are fully closed when the Rate Control Handle is resting on the stop #0. If not, please adjust control rod at the pivot to ensure the shut-off is fully closed with the handle at position at #0. Move the spreader slightly to confirm the calibration because of the cam.

FLEX-SELECT® BROADCAST SPREADER SETTING MATRIX

GRANULAR MATERIAL

STANDARD-OUTPUT Tray

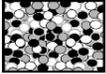
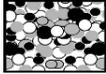
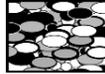
PARTICLE SIZES: Fine/Small → (SAND)  Medium → (HALF BB)  Large → (BB) Ice Melt 

Grams PER Square Metre	SETTING	SPREAD		SETTING	SPREAD		SETTING	SPREAD	
		WIDTH FT	METRES		WIDTH FT	METRES		WIDTH FT	METRES
5	7	18	5.5	9	24	7.3	14	36	11.0
10	10	18	5.5	13	24	7.3	18	36	11.0
15	13	18	5.5	16	24	7.3	23	36	11.0
20	14	18	5.5	20	24	7.3	27	36	11.0
24	16	18	5.5	22	24	7.3	30	36	11.0
29	18	18	5.5	25	24	7.3	23 x 2 pass	36	11.0
34	20	18	5.5	27	24	7.3	25 x 2 pass	36	11.0
39	22	18	5.5	28	24	7.3	27 x 2 pass	36	11.0
44	24	18	5.5	30	24	7.3	28 x 2 pass	36	11.0
49	26	18	5.5	22 x 2 pass	24	7.3	30 x 2 pass	36	11.0

GRASS SEED

Grams PER Square Metre	FINE		COARSE			
	SETTING	SPREAD WIDTH FT	SETTING	SPREAD WIDTH FT		
10	14	8	2.4	22	14	4.3
15	16	8	2.4	25	14	4.3
20	18	8	2.4	28	14	4.3
25	20	8	2.4	30	14	4.3

Calibration: Start by ensuring that your spreader calibration is correct. Make sure the drop holes in the **STANDARD-OUTPUT Tray** are fully open when the Rate Control handle is on #30. If not, please adjust control rod at the pivot to allow for a full open hopper holes with the handle at position at #30.

GRANULAR MATERIAL

LOW-OUTPUT Black Tray

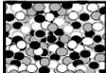
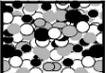
PARTICLE SIZES: Fine/Small → (SAND)  Medium → (HALF BB) 

Grams PER Square Metre	SETTING	SPREAD		SETTING	SPREAD	
		WIDTH FT	METRES		WIDTH FT	METRES
5	8	16	4.9	10	20	6.1
10	10	16	4.9	13	20	6.1
15	12	16	4.9	18	20	6.1
20	13	16	4.9	20	20	6.1
24	16	16	4.9	22	20	6.1
29	18	16	4.9	25	20	6.1
34	20	16	4.9	27	20	6.1
39	21	16	4.9	29	20	6.1
44	23	16	4.9	30	20	6.1
49	24	16	4.9	22 x 2 pass	20	6.1

Calibration: Start by ensuring that your spreader calibration is correct. Make sure the drop holes in the **LOW-OUTPUT TRAY** are fully closed when the Rate Control Handle is resting on the stop #0. If not, please adjust control rod at the pivot to ensure the shut-off is fully closed with the handle at position at #0. Move the spreader slightly to confirm the calibration because of the cam.

GRASS SEED

Grams PER Square Metre	FINE		COARSE			
	SETTING	SPREAD WIDTH FT	SETTING	SPREAD WIDTH FT		
10	15	9	2.7	21	15	4.6
15	18	9	2.7	24	15	4.6
20	21	9	2.7	27	15	4.6
25	24	9	2.7	30	15	4.6

GRANULAR MATERIAL

HIGH-OUTPUT Lt. Blue 2-hole Tray

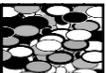
PARTICLE SIZES: Large → (BB) Ice Melt  EXTRA LARGE → ROCK SALT 

Grams PER Square Metre	SETTING	SPREAD		SETTING	SPREAD	
		WIDTH FT	METRES		WIDTH FT	METRES
5	7	28	8.5	8	26	7.9
10	10	28	8.5	11	26	7.9
15	12	28	8.5	13	26	7.9
20	14	28	8.5	14	26	7.9
24	15	28	8.5	15	26	7.9
29	17	28	8.5	16	26	7.9
34	20	28	8.5	17	26	7.9
39	21	28	8.5	18	26	7.9
44	23	28	8.5	19	26	7.9
49	24	28	8.5	21	26	7.9

Calibration: Start by ensuring that your spreader calibration is correct. Make sure the 2 drop holes in the **HIGH-OUTPUT TRAY** are fully closed when the Rate Control Handle is resting on the stop #0. If not, please adjust control rod at the pivot to ensure the shut-off is fully closed with the handle at position at #0. Move the spreader slightly to confirm the calibration because of the